

Area: 420m²

Frontage: 8.87m

Depth: 28m

STAGE 6 RELEASE 2

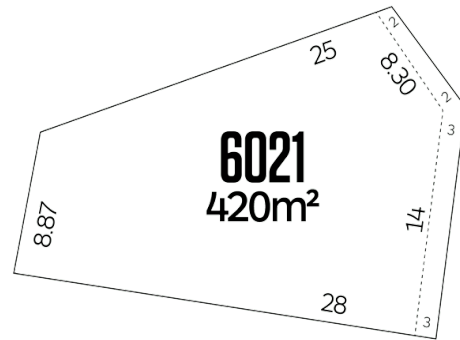

The peak of modern living.
ALIRABERWICK.COM.AU

WHILE BEST ENDEAVOURS HAVE BEEN USED TO PROVIDE INFORMATION IN THIS PUBLICATION THAT IS TRUE AND ACCURATE, ALIRA, ITS CONSULTANTS, AGENTS AND RELATED ENTITIES ACCEPT NO RESPONSIBILITY AND DISCLAIM ALL LIABILITY IN RESPECT TO ANY ERRORS OR INACCURACIES IT MAY CONTAIN. PROSPECTIVE PURCHASERS SHOULD MAKE THEIR OWN ENQUIRIES TO VERIFY THE INFORMATION CONTAINED HEREIN.

ALIRA

AT BERWICK

MASTERPLAN



The peak of modern living.
ALIRABERWICK.COM.AU

WHILE BEST ENDEAVOURS HAVE BEEN USED TO PROVIDE INFORMATION IN THIS PUBLICATION THAT IS TRUE AND ACCURATE, ALIRA, ITS CONSULTANTS, AGENTS AND RELATED ENTITIES ACCEPT NO RESPONSIBILITY AND DISCLAIM ALL LIABILITY IN RESPECT TO ANY ERRORS OR INACCURACIES IT MAY CONTAIN. PROSPECTIVE PURCHASERS SHOULD MAKE THEIR OWN ENQUIRIES TO VERIFY THE INFORMATION CONTAINED HEREIN.

